



AE2400 Series Installation Guide

GENERAL INFORMATION

This document contains information for installing the MEI AE2400 Series Bill Acceptor. This Bill Acceptor is designed to fit into the standard bill acceptor opening provided by amusement machine manufacturers. It mounts on either the existing four mounting studs located in the amusement machine or on the mounting bracket provided in various mounting kits.

Features of the AE2400 include:

- \$1, \$2 and \$5 bill acceptance
- Four Direction bill acceptance
- Re-programmable Flash Memory (Flashport™)
- Coupon configuration
- Lighted bezel (On Compact model only)
- Easy Access to the bill path even while mounted
- Diagnostic LED (see back of unit)
- Enhanced security
- Factory set to four pulses per dollar

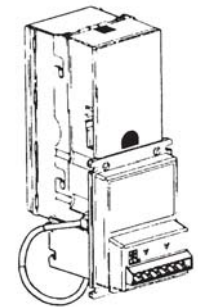

Figure 1

FLASHPORT™

The AE2400 Bill Acceptor with MEI Flashport™ has the ability to update software in the field by flash downloading.

INTERFACE OPTIONS

The 24V and 115V AE2400 supports pulse interfaces. Depending upon the model you order, one of the following harnesses will be supplied:

250079022 - 115 VAC Power / Enable Cable (Pulse Interface)

250071021 - 24 VAC Power / Enable Cable (Pulse Interface)

For further information on either interface harnesses or mounting kits, please contact your supplier or MEI Service Center.

MEI

Technical Support 1(800)345-8172
Customer Support 1(800)345-8215
<http://www.meigroup.com>



©2007 MEI, Inc.
www.meigroup.com

Part # 250057042
Revision G7

INSTALLATION INSTRUCTIONS

1. Set Bill Acceptor option switches. See Figure 2.

Note: When you receive the product, all switches are off. This will automatically enable the options as follows:

- Accept \$1,\$2, and \$5 dollar bills.
- Four way accept.
- High Security accept.
- 50ms on/50 ms off pulse (short pulse).
- Four pulses per dollar.
- Always enabled.

Important note: Placing any switch ON will override the above options, and the Bill Acceptor will operate according to the switch settings label! (See Figure 2)

NOTE: The unit may be configured with the attached coupon rather than using the option switches. *For coupon configuration, turn all option switches OFF and proceed to Coupon Configuration instructions on page 4.*

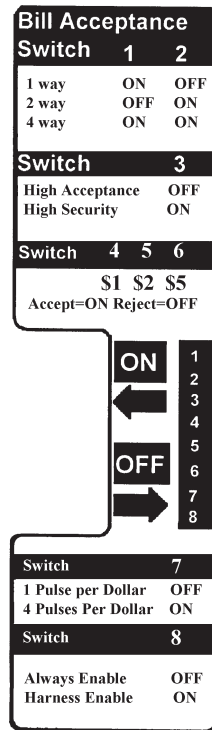
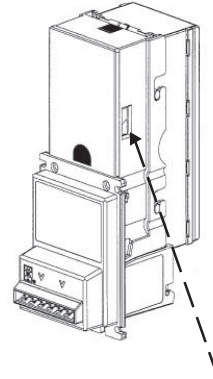

Figure 2

2. Remove power from the entire machine.

3. Install the AE2400 onto the Bill Acceptor mounting studs and through the mounting hole of the amusement machine. Secure using the appropriate hardware.

Configuration Coupon

Electronic copies of this manual will not have the coupon included. Please contact MEI if you need a configuration coupon

NOTES

INSTALLATION INSTRUCTIONS (CONTINUED)

4. Connect the AE2400 to the appropriate interface harness. A power cord (available separately - MEI Part No. 01-12-139-4- 110V only) may be used for supplying power to the bill acceptor and for routing pulse credits to a coin switch.

Forcing harness(es) into bill acceptor will cause pins to bend or break!

On 110V units, attach the enclosed tie-wrap to the mounting stud closest to the harness connection on the Bill Acceptor. Pull tie-wrap tightly around harness wires, including ground wire (equipped with ring terminal), to provide strain relief. **See Figure 3.**

5. On 110V units, place the ring terminal of the grounding wire to an earth ground location within the machine. Secure with the appropriate hardware.

IMPORTANT NOTE TO OEMs: Step 5 must be performed prior to Machine Dielectric Voltage - Withstand (Hi-Pot) Testing.

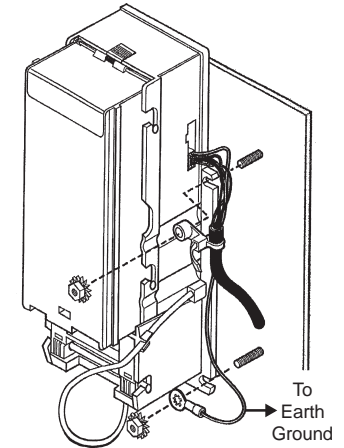

Figure 3

6. Apply power to the machine.

Observe that the LED status indicator on the back of the AE2400 is ON and NOT flashing. This condition indicates that the unit is ready to accept bills.

- If the light is OFF, check to ensure that power has been applied.
- If the light is flashing, refer to the label located on the back of the magazine for a description of diagnostic codes.

7. Check operation

- Insert a \$1 bill and observe that it is accepted and stacked.
- Repeat for other enabled bills.
- Insert a \$5 bill and verify that proper credits have been established.
- If the machine display indicates that a credit was missed; reconfigure the AE2400, using coupon, for **LONG PULSE** (60ms on/300ms off).

8. Remove bills and check status

- Instructions for bill removal are located on a label at the back of magazine.
- Verify that the LED status indicator remains steady ON.

COUPON CONFIGURATION (ALL SWITCHES OFF)

NOTES

1. **Carefully remove the coupon** from this Installation Guide. Copies are usable if made on a standard, carbon-based, non-color copier, AND if cut to match the size of the attached coupon. **(Coupon can be found on page 11.)**

2. **Fill out the coupon using a #2 pencil. Fill in one block for each line. Do not mark the back of the coupon.**

Section 1 - Bill Direction Enable one or two-way (face-up) or four-way acceptance (all directions).

Section 2 - Bill Denomination Fill in one block for each denomination. Select High Accept for maximum bill acceptance. Select High Security for a higher level of discrimination. Select OFF to reject bills of that denomination.

Section 3 - Pulse Timing Select either SHORT, LONG pulse timing.

Section 4 - Pulses per Dollar Most machines use four pulses per dollar.

Section 5 - Bezel Lights Select ON or Flashing (Compact Bezel only).

3. **Locate the service button** on the back of the unit (refer to Figure 4). depress the button once to enter coupon set-up mode. Depressing again will exit the mode.

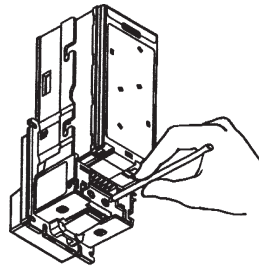

Figure 4

4. **Insert coupon and verify settings were accepted.**

ACCEPTED: Coupon returned immediately and LED flashes 10 times when coupon pulled out.

REJECTED: Coupon returned after ten seconds. LED flashes number of times corresponding to section improperly filled out. Example: Six flashes for improper section six. If rejected, review instructions or try new coupon.

CLEANING

The AE2400 series will not need cleaning as often as magnetic sensing Bill Acceptors. If cleaning is required, use a soft cloth moistened with mild, non-abrasive detergent. Refer to label located on the back of the magazine for cleaning instructions.

NOTES

CHECK LIST

Unit dead (won't power up).	<ol style="list-style-type: none">1. Harness(es) may be loose, not properly connected, or bent pins.2. Check source voltage to ensure that power is being supplied to the bill acceptor.
Red message light flashing twice (disabled from mech / VMC). NOTE: If flashing other than twice refer to label located on back of the magazine.	<ol style="list-style-type: none">1. Check settings on the bill acceptor to ensure that proper interface options are being used. If only the 9 pin power cable is being used make sure that switch # 8 is in the off position (Always Enable)
Unit takes a bill, but won't credit.	<ol style="list-style-type: none">1. Check to ensure that the proper interface has been selected (long / short pulse).

PINOUT INFORMATION FOR 30 PIN CONNECTOR

Connector Assignment for the 9 pin Cable

- Pin 1 NEUTRAL INHIBIT
- Pin 2 NEUTRAL ENABLE
- Pin 3 HOT ENABLE
- Pin 4 115 VAC HOT (POWER)
- Pin 5 24 VAC HOT (POWER)
- Pin 6 115 / 24 VAC NEUTRAL
- Pin 7 CREDIT RELAY (N.O.)
- Pin 8 CREDIT RELAY (COMM.)
- Pin 9 Reserved

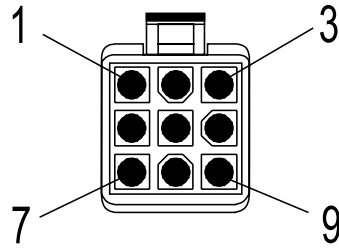

9 - Pin Mating Connector
AMP "MATE-N-LOCK" (9) pin
AMP Part#172161-1 Shell
AMP Part#170364-1 Male Pin
#22 Gauge Wire Recommended

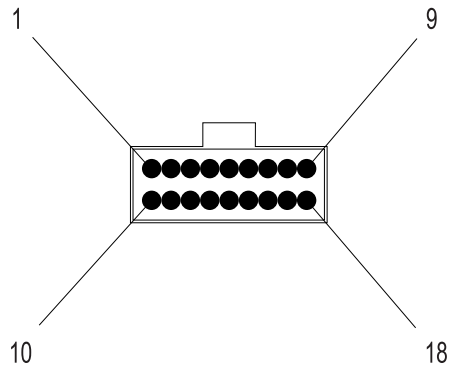

18 - Pin Mating Connector
AMP "MODU" (18) pin MT receptacle
AMP Part#102398-7 IDC Connector Housing
AMP Part#102536-7 Back cover
AMP Part#102681-4 Front cover
#22 Gauge Wire Recommended

PINOUT INFORMATION FOR 30 PIN CONNECTOR (CONT.)

1	2	3	4	5	6	7	8	9	10	11	12	13	14	15
16	17	18	19	20	21	22	23	24	25	26	27	28	29	30

115 Volt AC Model

24 Volt AC / MDB Model

GAMING PINOUTS ONLY!

• Pin 1	CREDIT RELAY, Common	Same
• Pin 2	RESERVED	CREDIT RELAY N.O.
• Pin 3	RESERVED	24 VAC HOT (Power)
• Pin 4	115 VAC NEUTRAL (Power)	RESERVED
• Pin 5	RESERVED	KEY
• Pin 6	KEY	RESERVED
• Pin 7	CREDIT-PULSE_NOT	Same
• Pin 8	INTERRUPT_NOT	Same
• Pin 9	SERIAL / PULSE_NOT	Same
• Pin 10	LOW_LEVEL_GND	Same
• Pin 11	SERIAL DATA OUT	Same
• Pin 12	NOT USED	Same
• Pin 13	NOT USED	Same
• Pin 14	NOT USED	Same
• Pin 15	NOT USED	Same
• Pin 16	CREDIT RELAY, Normally Open	DC RETURN
• Pin 17	RESERVED	Same
• Pin 18	RESERVED	Same
• Pin 19	KEY	RESERVED
• Pin 20	115 VAC HOT (Power)	24 VAC NEUTRAL (Power)
• Pin 21	EARTH GROUND	KEY
• Pin 22	OUT-OF-SERVICE_NOT	Same
• Pin 23	RESERVED	Same
• Pin 24	ACCEPT ENABLE_NOT	Same
• Pin 25	OUT OF SERVICE POWER	Same
• Pin 26	SEND_NOT / SERIAL DATA IN	Same
• Pin 27	RESERVED	Same
• Pin 28	RESERVED	Same
• Pin 29	RESERVED	Same
• Pin 30	RESERVED	Same